



NACHI

SP19CSM

SP21CSM

SP25CSM

SKYMASTER

class **19** m

Max. floor height Max. working radius
19.0m - R15.5m

Max. load capacity Machine Weight
250kg - W11,400kg

class **21** m

Max. floor height Max. working radius
21.0m - R18.8m

Max. load capacity Machine Weight
250kg - W14,750kg

class **25** m

Max. floor height Max. working radius
25.0m - R17.0m

Max. load capacity Machine Weight
250kg - W14,400kg

*Machine weight may vary depending on options and/or local standards.



**SP21C1SM with optional equipment pictured.

FEATURES

Reduced risk of damage to rotation device

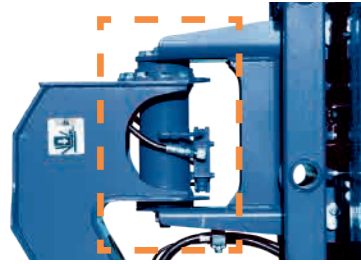

When a large load is applied to the basket, the basket rotation mechanism with hydraulic rotary actuator operates to release the load and decrease risk of damage.

*Damage may occur when force is applied at rotation end and/or past rotation angle.

Improved safety devices



Bar-type touch switch is utilized. It can correspond to basket deformation and it is more reliable than previous wire-type switch.

Improved engine maintenance



A gull-wing cover and swing-out engine base are utilized. The ease of maintenance and cleaning are improved.

← Engine slides out

Reduced environmental burden and improved fuel efficiency



New Tier 4 engine reduces environmental burden. In addition, engine speed control in accordance with work load increases fuel efficiency.
(Tier 2, Tier 3 engine can also be available)

MACHINE DIMENSIONS

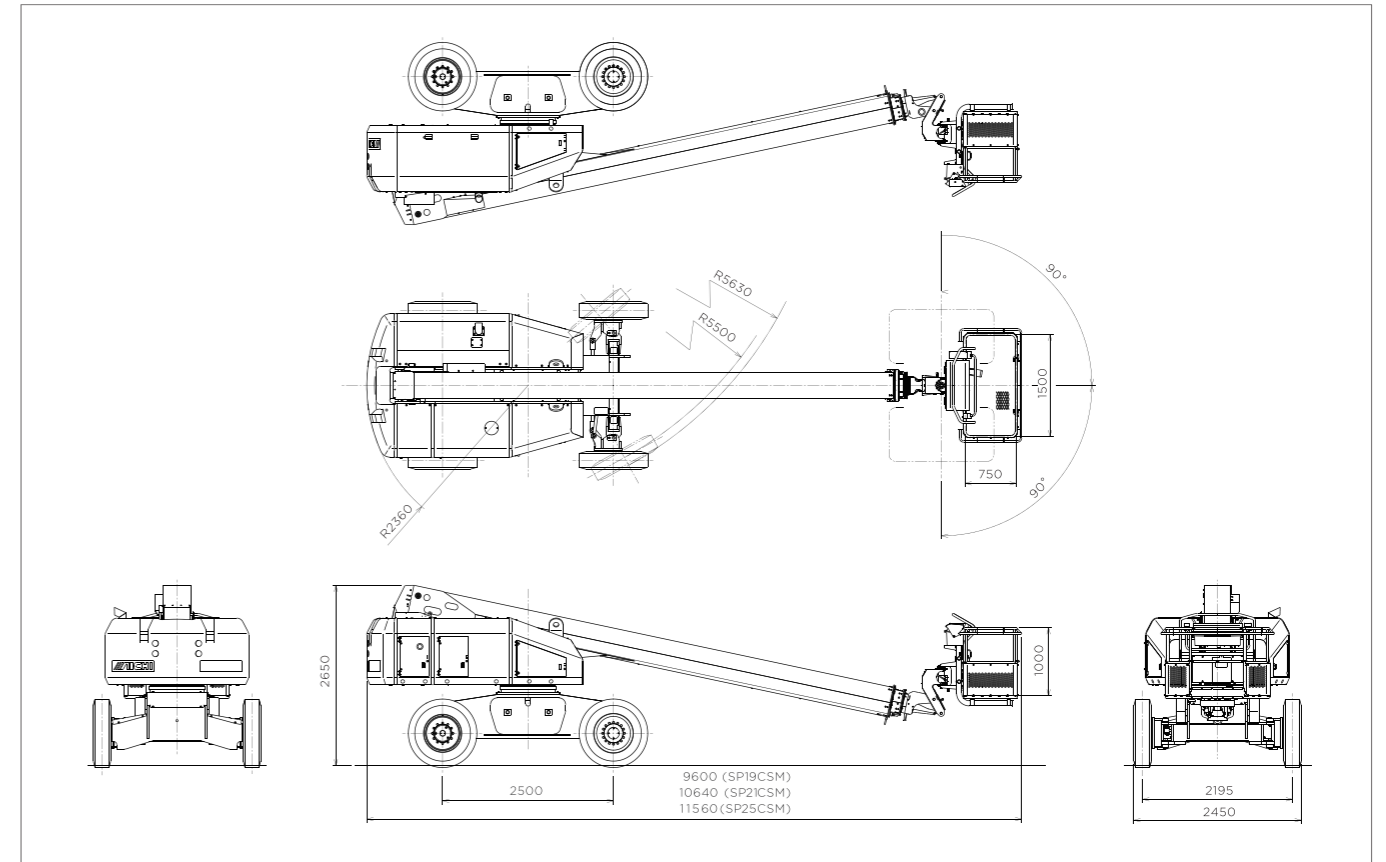

EQUIPMENTS



Hoist wire protector (option)

Reduces the risk of damage to the boom caused by wires used to hoist the machine.

standard equipment

option



Rotation beacon (option)

Illuminates while the engine is running and indicates to nearby personnel that the machine is operating.



Cylinder boots (option)

Can be attached to the elevation, steering, and lower leveling cylinders. Protects the cylinder rod from dust and weld spatter.

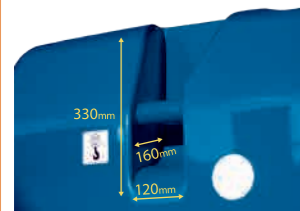

Hoist points

These are hoist hook attachment points. Opening dimensions : (H) 330mm x (L) 120mm x (D) 160mm Diameter of bar: 50mm Located approx. 2m from the ground

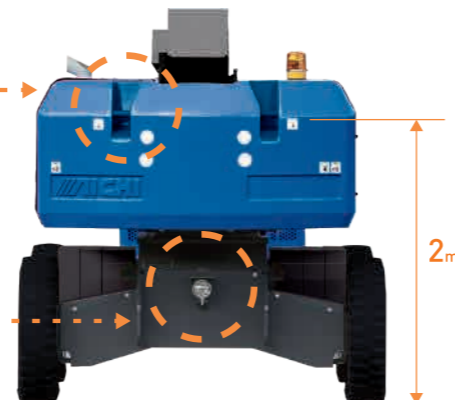

2m



Reinforced sweepers (option)

These sweepers reduce the risk of foreign objects entering the inside of the boom.



Headlights (option)

Aids visibility in the direction of travel.
*Can be installed in front and back.



Non-marking/non-puncture tires (option)

These tires mark less than black tires when travelling.

SPECIFICATIONS

MODEL/TYPE	Model	SP19CSM	SP21CSM	SP25CSM
	Type	Wheel type aerial work platform		
PLATFORM	Max. load capacity (crews)	250kg (2persons)		
	Max. floor height	19.0m	21.0m	25.0m
	Max. working radius	15.5m	18.8m	17.0m
	Inside dimensions	(L)0.75 x (W)1.5 x (H)1.0m		
	Rotation angle	L:90° / R:90°		
BOOM	Type	3 stages telescopic		
	Extension stroke/speed	10.26m / 35 sec (extend/retract)	11.3m / 40 sec (extend/retract)	14.73m / 60 sec (extend/retract)
	Elevation angle/speed	- 12° to 70° / 40 sec (up/down)		- 12 to 70° / 50 sec (up/down)
ROTATION DEVICE	Rotation angle	360° continuous		
	Rotation speed	0.75rpm		
PERFORMANCE	Traveling speed	stowed	0 to 4.0km/h	
		raised	0 to 1.0km/h	
	Gradeability	stowed	21% (12°)	
	Allowable tilt angle	3°		
	Turntable tailswing radius	2.36m		
	Machine weight*	11,400kg	14,750kg	14,400kg
	Max. ground bearing pressure*	1,350kPa	1,500kPa	1,500kPa
	Turning radius (outside of tire)	5.63m		
ENGINE	Max. output	51.7kW (2,500rpm)		
	Max. torque	2.41kW (1,625rpm)		
	Displacement	3.318L		

*Machine weight may vary depending on options and/or local standards.

WORKING RANGE DIAGRAMS

SP19CSM

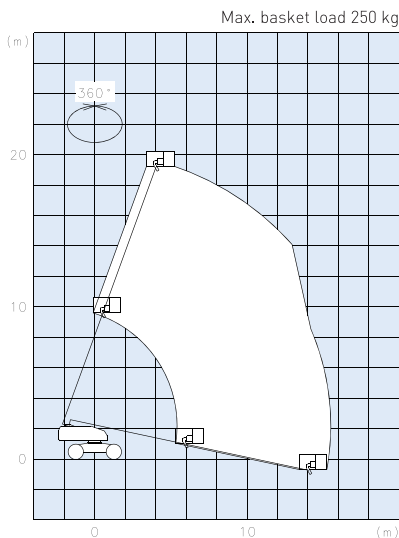

SP21CSM

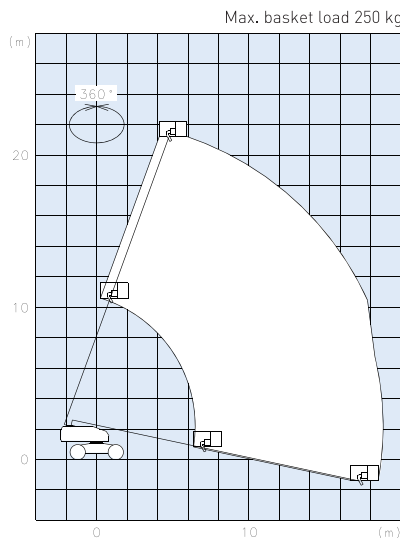

SP25CSM

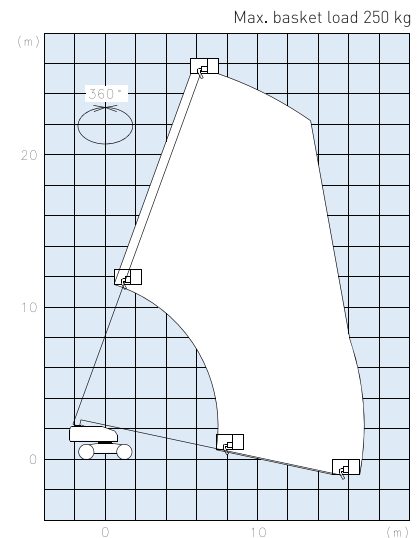

- note1 - Working range diagrams do not include boom deflection.
 2 - Working range diagrams are the same regardless of boom rotation angle.
 3 - Working range diagrams are based on the machine being on a level surface.
 4 - Counterweight must be installed in its designated location.
 5 - Maximum load capacity may vary depending on options equipped.



1152-10 Ryoke Ageo Saitama 362-8550 Japan
 TEL: +81-48-781-6907 URL: <http://www.aichi-corp.jp>

DISTRIBUTOR

Safety instructions



- Operator of the machine must receive safety training to ensure safe operations. Incorrect use of the machine can cause serious injury or death. All personnel are requested to receive safety training and only trained and authorized personnel are permitted to operate the machine.
- Ultimate compliance to national safety regulations is the responsibility of the user and their employer.
- All owners and users of the machine must read, understand, and comply with all applicable regulations.

*Due to continuous product improvements, we reserve the right to make specification and/or equipment changes without prior notice.

*The photos and/or drawings in this brochure are for illustrative purpose only.

*This information, while believed to be completely reliable is not be taken as warranty for which we assume legal responsibility.